

LINSY 林氏家居

安装示意图/Assembly Instruction

产品名称 Model NO.	沙发
产品型号 Product model	BS806-A&B#
产品组合 Product portfolio	①双人 2seat
尺寸规格 Specification	①(1410*860*880)mm

编号 NO.	名称 Name	规格 Specification	数量 QTY	材质 Material
1	双人 2seat	1410*860*880	1	松木+胶合板+海绵+布料 Pine wood + Plywood + Sponge+Cloth

制图 Draw 郑铭浩

如何区分沙发的左右方向?
How to zone the left and right direction of the sofa?

(图示仅供分辨方向用/Picture are for orientation only)

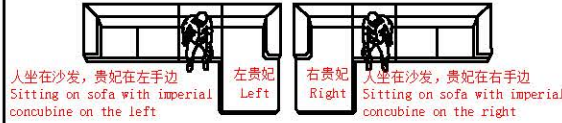

安装人数 Installer

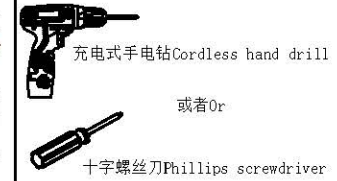
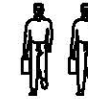

客户安装前须知:
Customers need to know before installation:
此安装图为“双人”的位置关系。
This installation picture is "2seat"

2-1

配件表 Accessories list

编号NO.	名称 Name	图示 Icon	数量 QTY	双人 3seat	
A	说明书(含安装图) Mounting Instruction (with drawing)		1	1	
B	脚-(直径50*155mm)橡胶原木木脚(含M8锤母) Foot - (diameter 50*155mm) rubber wood color wood foot (including M8 hammer nut)		4	4	
C	脚-(直径30*145-160mm)可调一字五金脚 Foot-(diameter 30*145-160mm) Adjustable metal foot		1	1	
D	双头螺杆-(M8*45mm)彩锌 Double screw M8*45mm		1	1	
E	M8*70mm全牙螺杆 threaded rod M8*70		4	4	
	3公分白色木布条		1	0	1

注: 此木布条用于客户拆洗后使用

双人 2seat

STEP 1:



图1: 拉开拉链, 取出配件
Figure 1: Unzip and remove the fitting



图2: 边脚安装示意图①
Figure 2: Side and foot installation diagram①

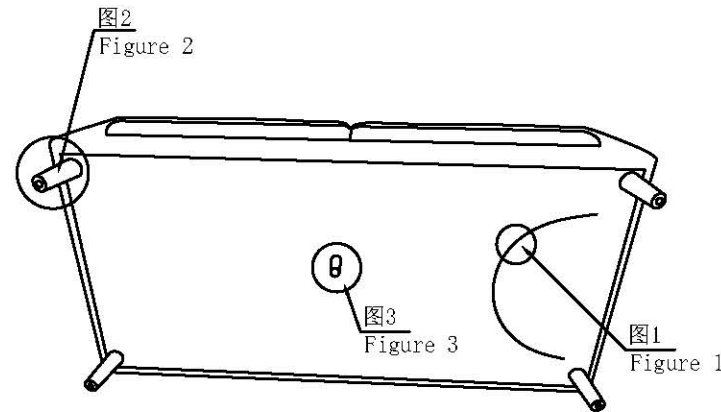

*安装原装脚时, 必须把带钉小胶脚拆除!
* When installing the original feet, the small rubber feet with nails must be removed!

图2: 边脚安装示意图②
Figure 2: Side and foot installation diagram②

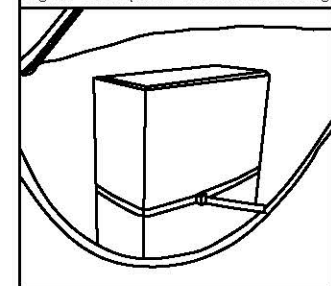
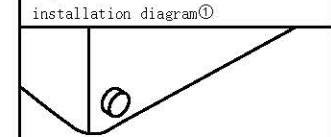

图3: 中脚安装示意图
Figure 3: Middle foot installation diagram



组合图 Combination

双人 2seat

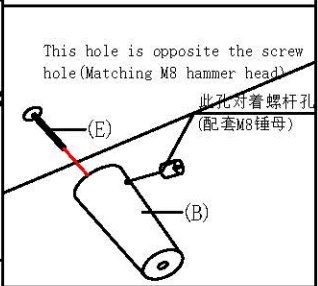
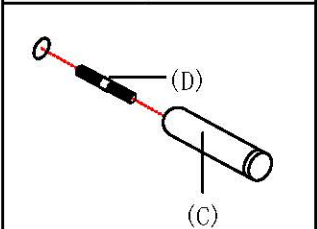
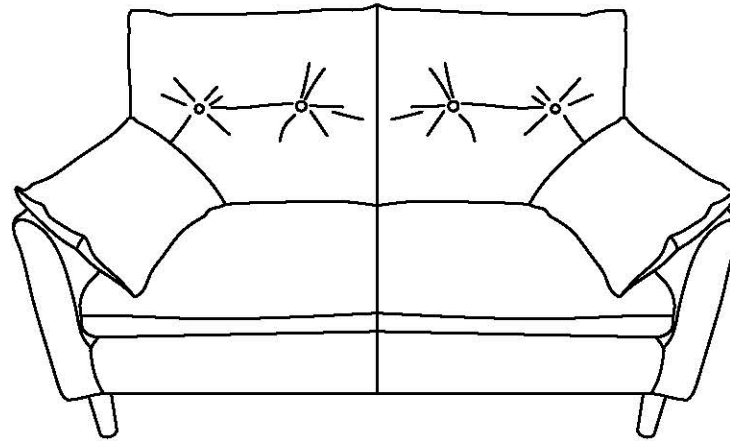

注:

1) 安装图图示方向为指示方向, 具体左右摆放方式以实物为准。

The direction shown in the installation diagram is the indicated direction, and the specific left and right placement method is subject to the actual object.

2) 产品安装图中产品规格涵盖了该款式的完整组合件, 详细配套组合件请参考实物。

The product specifications in the installation diagram cover the complete assembly of this style. For detailed matching assembly, please refer to the actual product.

LINSY 林氏家居

安装示意图/Assembly Instruction

产品名称 Model NO.	沙发
产品型号 Product model	BS806-A&B#
产品组合 Product portfolio	①三人 3seat
尺寸规格 Specification	①(1700*860*880)mm

编号 NO.	名称 Name	规格 Specification	数量 QTY	材质 Material
1	三人 3seat	1700*860*880	1	松木+胶合板+海绵+布料 Pine wood + Plywood + Sponge+Cloth

制图 Draw 郑铭浩

如何区分沙发的左右方向?
How to zone the left and right direction of the sofa?

(图示仅供分辨方向用/Picture are for orientation only)

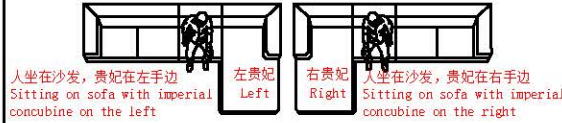

安装人数 Installer

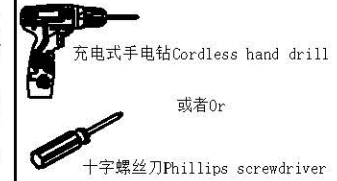
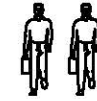

客户安装前须知:
Customers need to know before installation:
此安装图为“三人”的位置关系。
This installation picture is "3seat"

2-1

配件表 Accessories list

编号NO.	名称 Name	图示 Icon	数量 QTY	三人 3seat	
A	说明书(含安装图) Mounting Instruction (with drawing)		1	1	
B	脚-(直径50*155mm) 橡胶木原木色木脚(含M8锤母) Foot - (diameter 50*155mm) rubber wood color wood foot (including M8 hammer nut)		4	4	
C	脚-(直径30*145-160mm)可调一字五金脚 Foot-(diameter 30*145-160mm) Adjustable metal foot		1	1	
D	双头螺杆-(M8*45mm) 彩锌 Double screw M8*45mm		1	1	
E	M8*70mm全牙螺杆 threaded rod M8*70		4	4	
	3公分白色么术布条		1	0	1

注: 此么术布条用于客户拆洗后使用

三人 3seat STEP 1:



图1: 拉开拉链, 取出配件
Figure 1: Unzip and remove the fitting



图2: 边脚安装示意图①
Figure 2: Side and foot installation diagram①

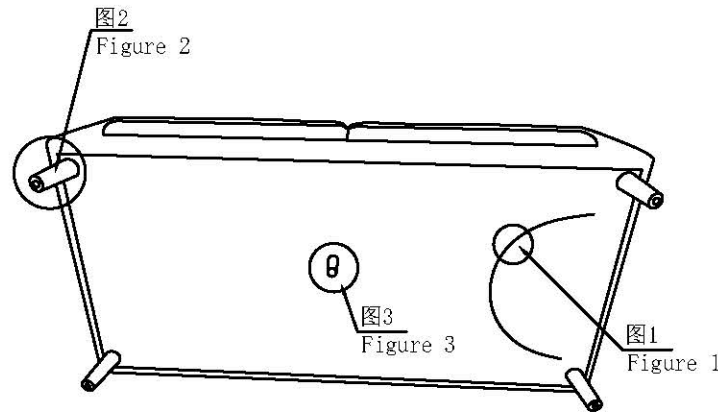

*安装原装脚时, 必须把带钉小胶脚拆除!
* When installing the original feet, the small rubber feet with nails must be removed!

图2: 边脚安装示意图②
Figure 2: Side and foot installation diagram②

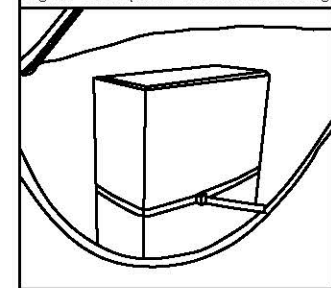
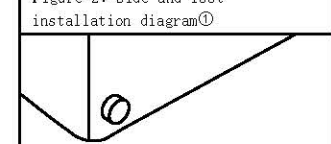

图3: 中脚安装示意图
Figure 3: Middle foot installation diagram



组合图 Combination

三人 3seat

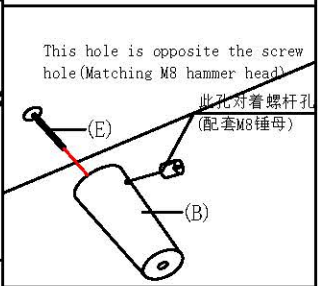
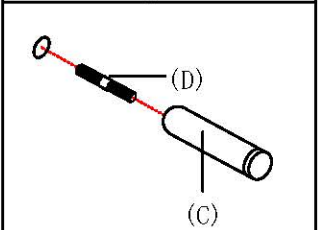
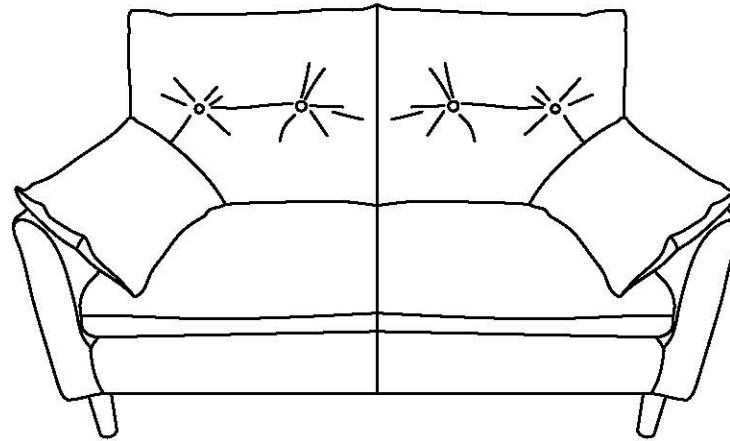

注:

1) 安装图图示方向为指示方向, 具体左右摆放方式以实物为准。

The direction shown in the installation diagram is the indicated direction, and the specific left and right placement method is subject to the actual object.

2) 产品安装图中产品规格涵盖了该款式的完整组合件, 详细配套组合件请参考实物。

The product specifications in the installation diagram cover the complete assembly of this style. For detailed matching assembly, please refer to the actual product.

安装示意图/Assembly Instruction

如何区分沙发的左右方向?
How to zone the left and right direction of the sofa?

(图示仅供分辨方向用/Picture are for orientation only)

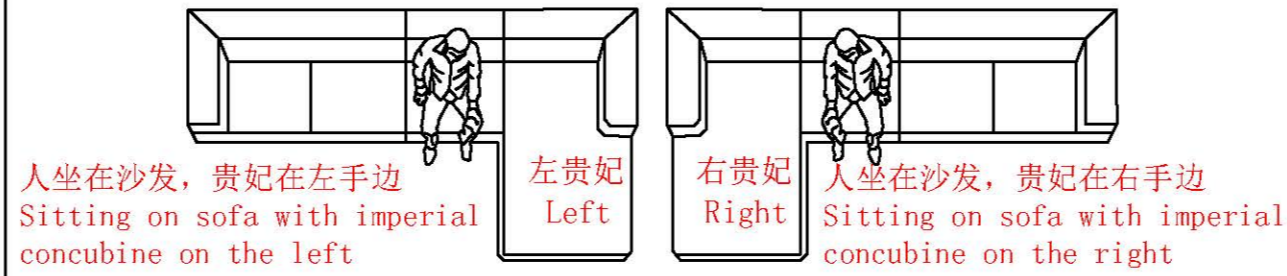

安装人数
Installer

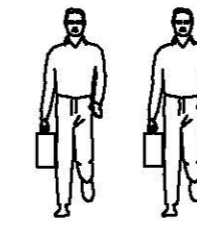

充电式手电钻Cordless hand drill

或者Or

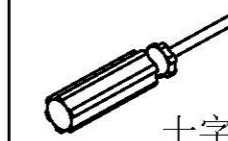

十字螺丝刀Phillips screwdriver

客户安装前须知:

Customers need to know before installation:
此安装图为“四人”的位置关系。
This installation picture is "4seat"

配件表 Accessories list

编号NO.	名称 Name	图示 Icon	数量 QTY	三人 3seat	
A	说明书(含安装图) Mounting Instruction (with drawing)		1	1	
B	脚-(直径50*155mm)橡胶木原木色木脚(含M8锤母) Foot - (diameter 50*155mm) rubber wood color wood foot (including M8 hammer nut)		4	4	
C	脚-(直径30*145-160mm)可调一字五金脚 Foot-(diameter 30*145-160mm) Adjustable metal foot		2	2	
D	双头螺杆-(M8*45mm)彩锌 Double screw M8*45mm		2	2	
E	M8*70mm全牙螺杆 threaded rod M8*70		4	4	
	3公分白色魔术布条		1	0	1

注: 此魔术布条用于客户拆洗后使用

四人 4seat

STEP 1:



图1: 拉开拉链, 取出配件
Figure 1: Unzip and remove the fitting



图2: 边脚安装示意图①
Figure 2: Side and foot installation diagram①

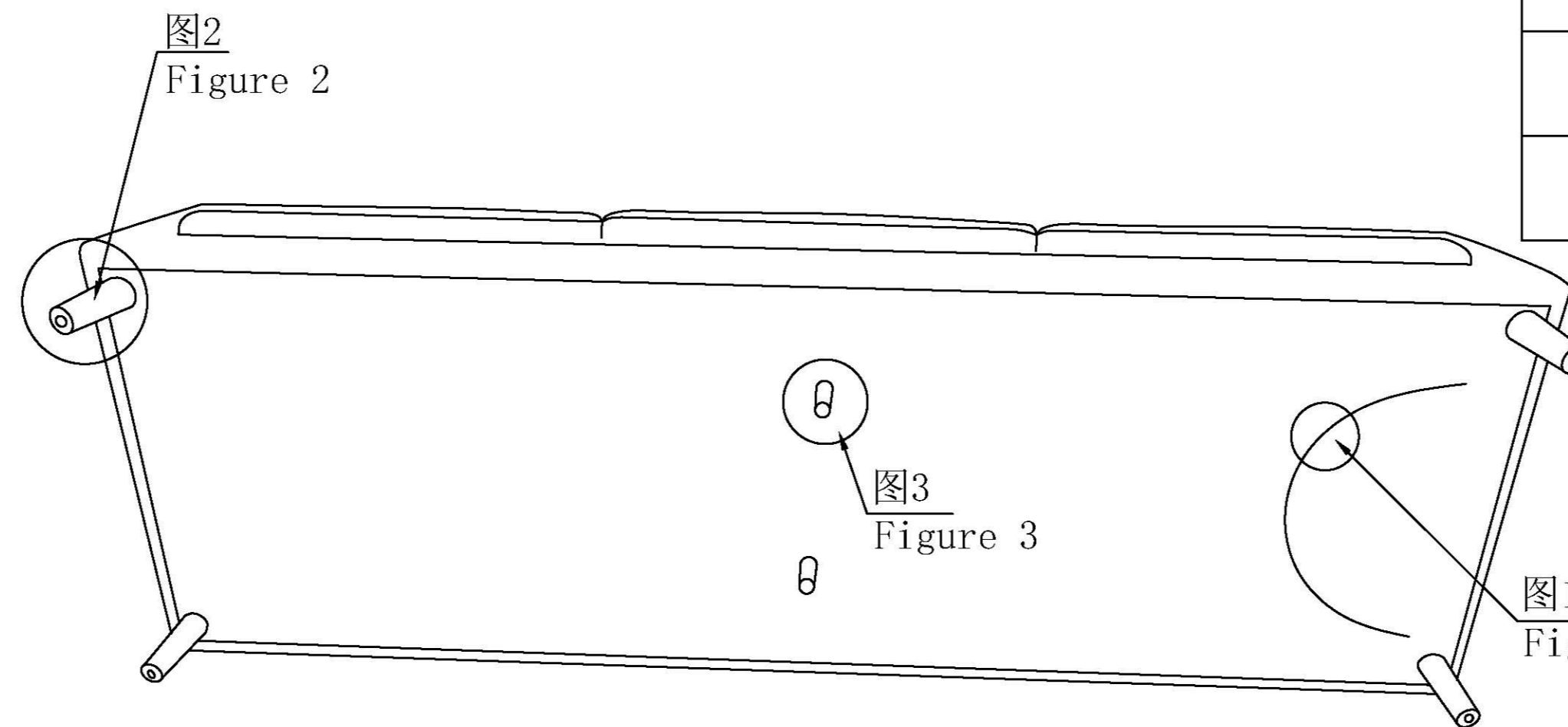

***安装原装脚时, 必须把带钉小胶脚拆除!**
*** When installing the original feet, the small rubber feet with nails must be removed!**

图2: 边脚安装示意图②
Figure 2: Side and foot installation diagram②

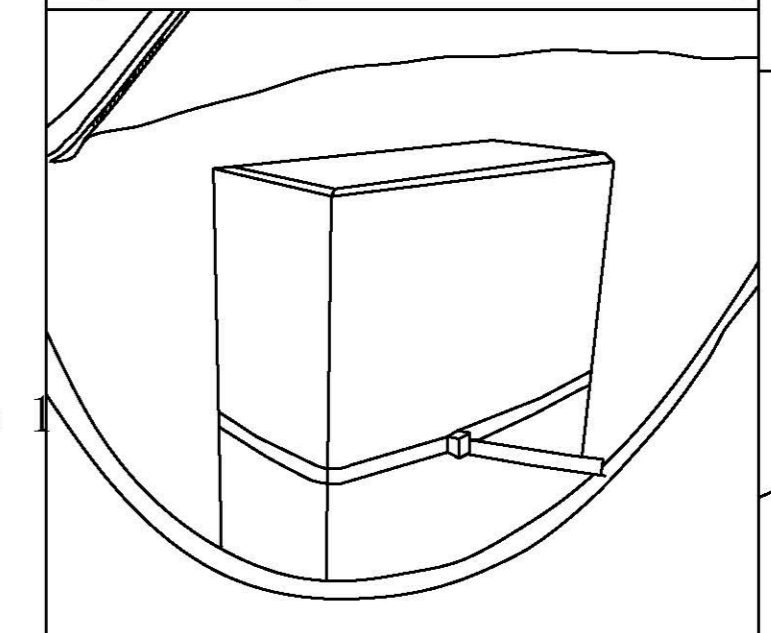
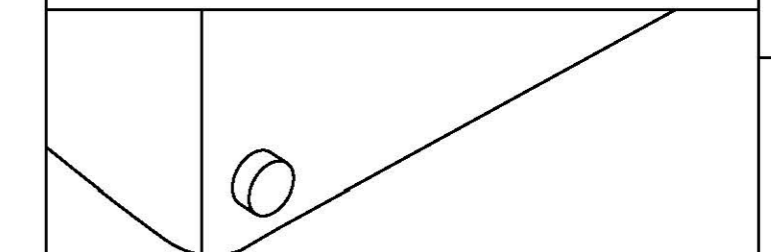

图3: 中脚安装示意图
Figure 3: Middle foot installation diagram



编号 NO.	名称 Name	规格 Specification	数量 QTY	材质 Material
1	四人 4seat	2020*860*880	1	松木+胶合板+海绵+布料 Pine wood + Plywood + Sponge+Cloth

制图 Draw 郑铭浩

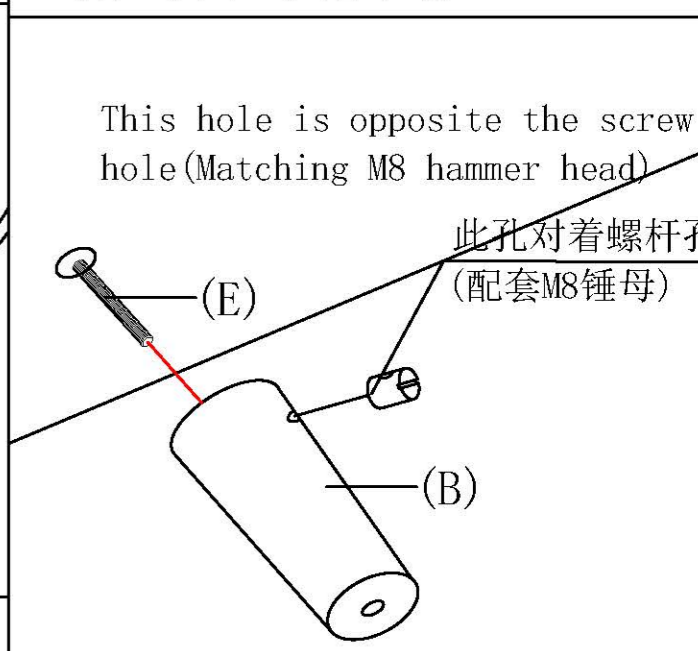
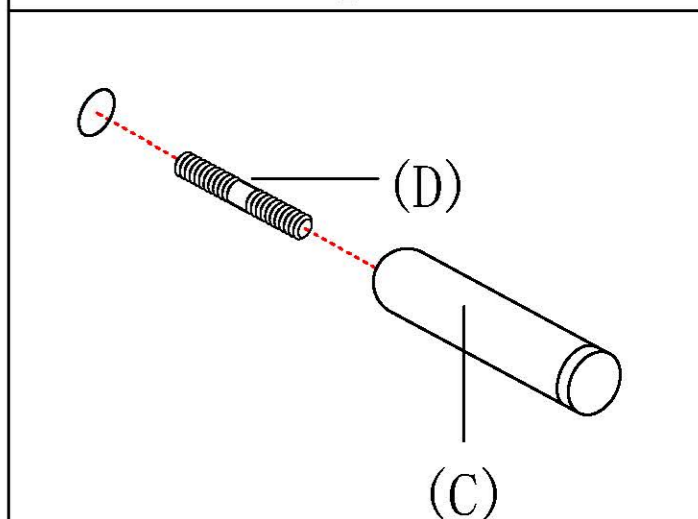
组合图 Combination

四人 4seat

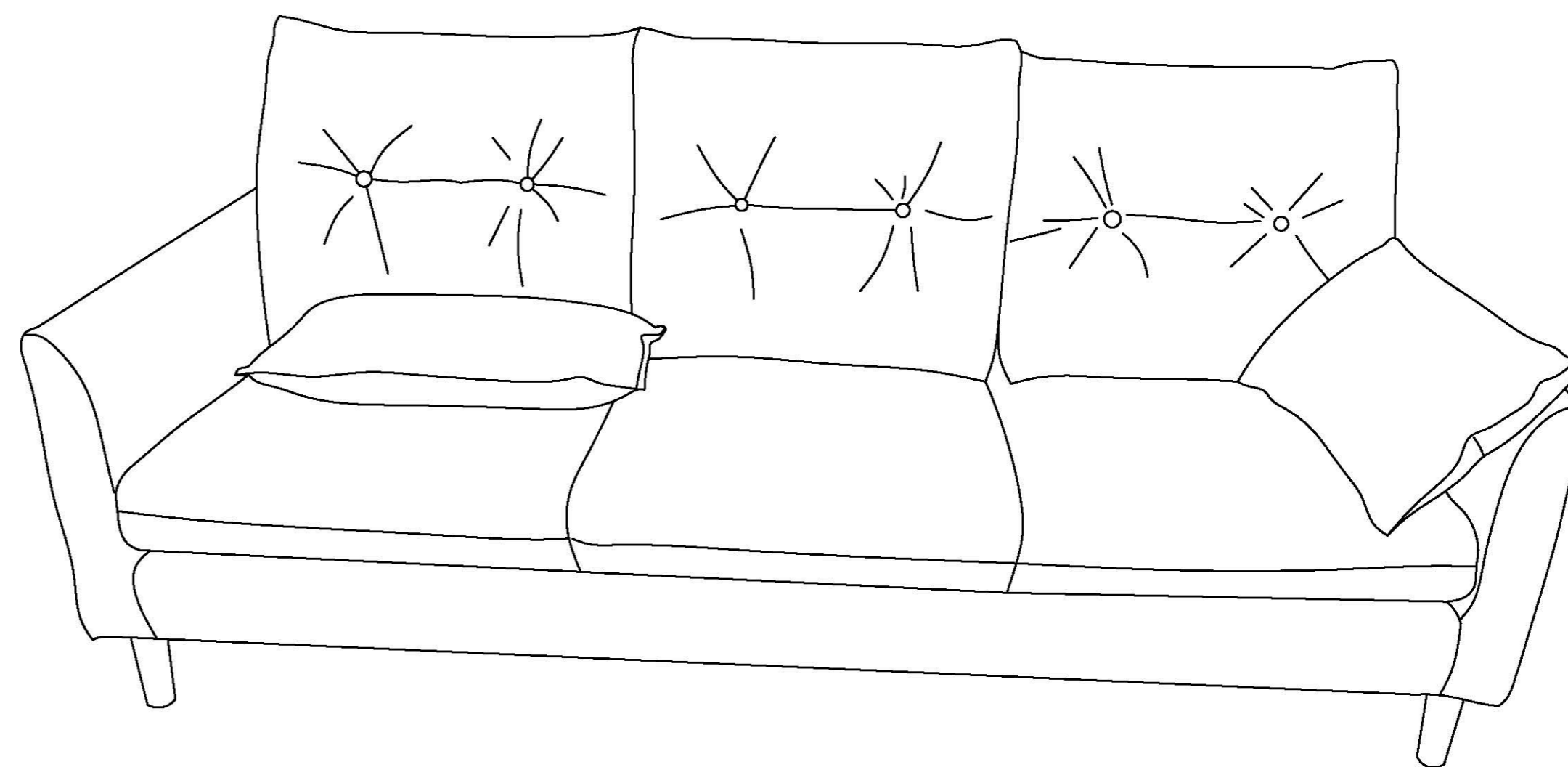

注:

1) 安装图图示方向为指示方向，具体左右摆放方式以实物为准。

The direction shown in the installation diagram is the indicated direction, and the specific left and right placement method is subject to the actual object.

2) 产品安装图中产品规格涵盖了该款式的完整组合件，详细配套组合件请参考实物。

The product specifications in the installation diagram cover the complete assembly of this style. For detailed matching assembly, please refer to the actual product.