

LINSY 林氏家居

安装示意图/Assembly Instruction

如何区分沙发的左右方向?
How to zone the left and right direction of the sofa?

(图示仅供分辨方向用/Picture are for orientation only)

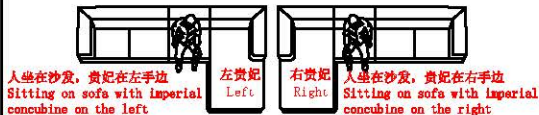

安装人数
Installer



充电式手电钻Cordless hand drill

或者Or



十字螺丝刀Phillips screwdriver

客户安装前须知:

Customers need to know before installation:
此安装图为“双人”的位置关系。
This installation picture is "Loveseat"

2-1

大三人 Big Three-seater

配件表 Accessories list

编号NO.	名称 Name	图示 Icon	数量 QTY	大三人 Big Three-seater
A	说明书(含安装图) Mounting Instruction (with drawing)		1	1
B	M8*50斜边十字螺栓 M8*50 bevel cross bolt		14	14
C	M5*50自攻螺丝 M5*50 self tapping screw		3	3
D	M8垫片 M8 pad		14	14

产品名称 Model NO.	沙发			
产品型号 Product Model	TBS606-BL#			
产品组合 Product portfolio	①大三人 Big Three-seater			
尺寸规格 Specification	①(1510*870*1030)			

成品部件明细 Product Parts Details	编号 NO.	名称 Name	规格 Specification	数量 QTY	材质 Material
1	大三人 Big Three-seater	1510*870*1030	1	胶合板+海绵+人造皮+铁 Plywood + Sponge+Artificial leather+iron	
制图 Draw	C40				



图1: 靠背铁架安装示意图
Installation diagram of the backrest iron frame

图2: 扶手安装示意图
Schematic diagram of handrail installation

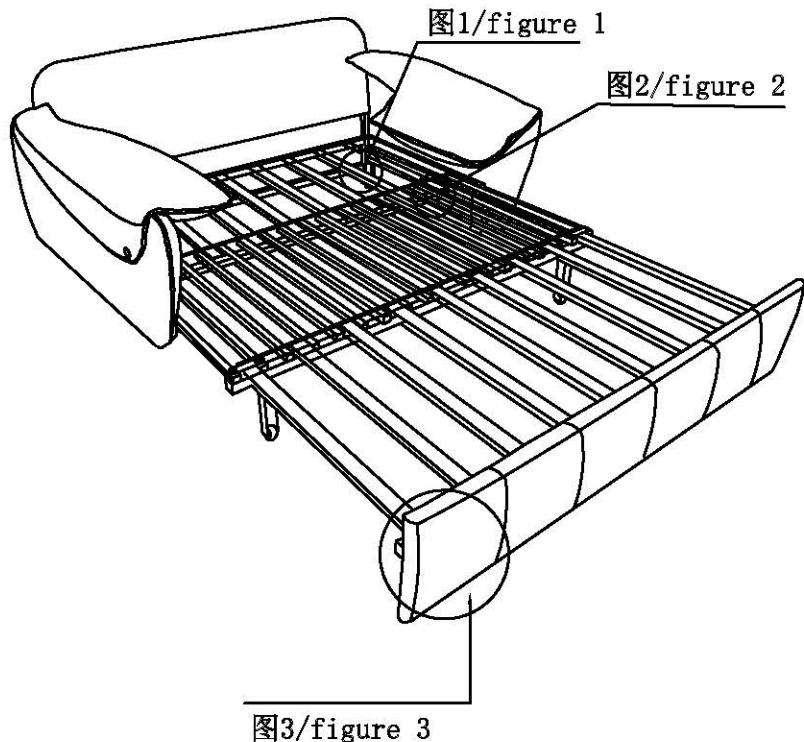

图3: 座前板安装示意图

Installation diagram of the front seat panel



组合图 Combination

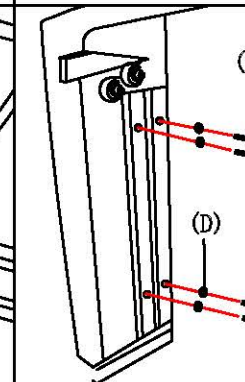
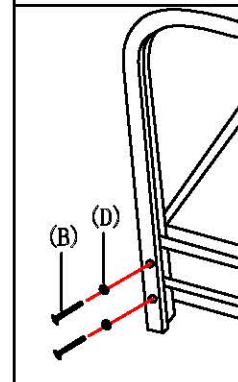
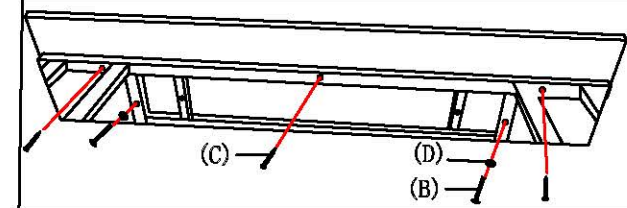
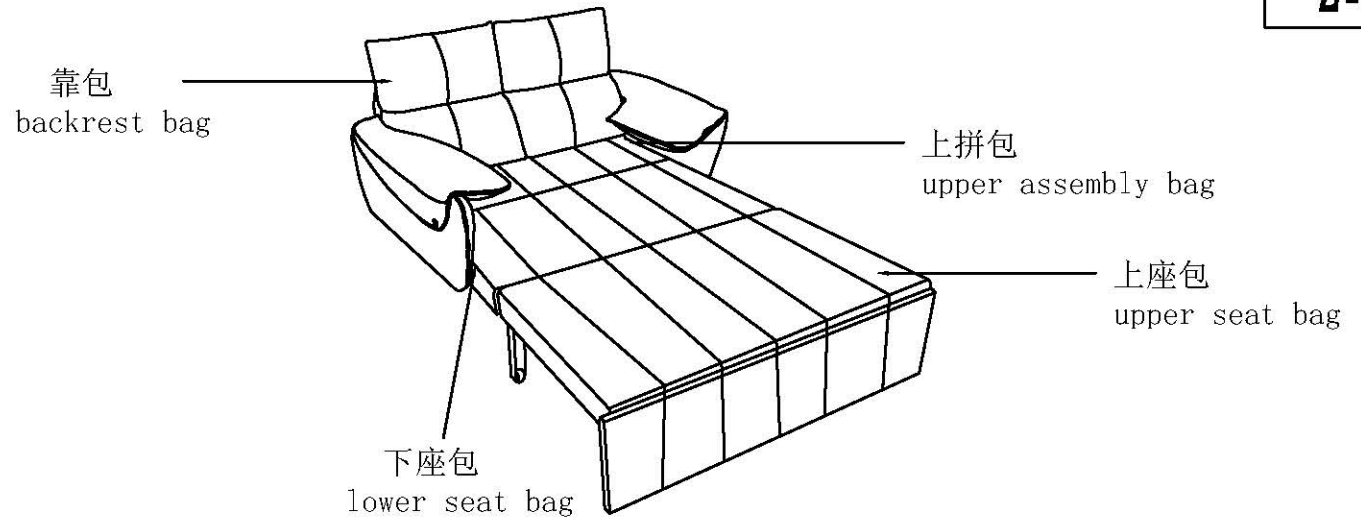

沙发床: 依次放上拼包*1, 下座包*1, 上座包*1, 靠包*2

Sofa bed: Place the upper assembly bag *1, the lower seat bag *1, the upper seat bag *1, and the backrest bag *2 in sequence

组合图 Combination

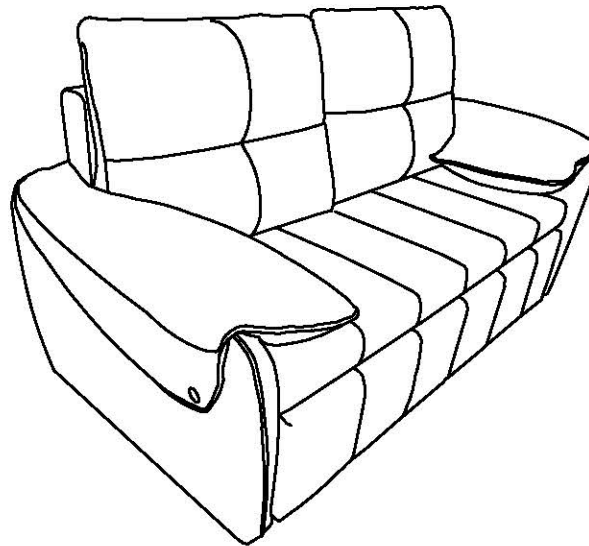

沙发: 依次放上下座包*1, 上座包*1, 上拼包*1, 靠包*2

Sofa: Place the upper and lower seat bags *1, the upper seat bag *1, the upper assembly bag *1, and the back bag *2 in sequence

注:

1) 安装图图示方向为指示方向, 具体左右摆放方式以实物为准。

The direction shown in the installation diagram is the indicated direction, and the specific left and right placement method is subject to the actual object.

2) 产品安装图中产品规格涵盖了该款式的完整组合件, 详细配套组合件请参考实物。

The product specifications in the installation diagram cover the complete assembly of this style. For detailed matching assembly, please refer to the actual product.

LINSY 林氏家居

安装示意图/Assembly Instruction

如何区分沙发的左右方向?
How to zone the left and right direction of the sofa?

(图示仅供分辨方向用/Picture are for orientation only)

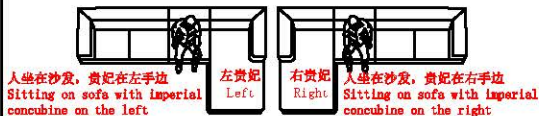

安装人数
Installer



充电式手电钻Cordless hand drill

或者Or



十字螺丝刀Phillips screwdriver

客户安装前须知:

Customers need to know before installation:
此安装图为“双人”的位置关系。
This installation picture is "Loveseat"

2-1

四人 Four-seater

配件表 Accessories list

编号NO.	名称 Name	图示 Icon	数量 QTY	四人 Four-seater
A	说明书(含安装图) Mounting Instruction (with drawing)		1	1
B	M8*50斜边十字螺栓 M8*50 bevel cross bolt		14	14
C	M5*50自攻螺丝 M5*50 self tapping screw		4	4
D	M8垫片 M8 pad		14	14

产品名称 Model NO.	沙发			
产品型号 Product Model	TBS606-B1#			
产品组合 Product portfolio	①四人 Four-seater			
尺寸规格 Specification	①(1810*870*1030)			

成品部件明细 Product Parts Details	编号 NO.	名称 Name	规格 Specification	数量 QTY	材质 Material
1	四人 Four-seater	1810*870*1030	1	胶合板+海绵+人造皮+铁 Plywood + Sponge+Artificial leather+iron	

制图 Draw C40



图1: 靠背铁架安装示意图
Installation diagram of the backrest iron frame

图2: 扶手安装示意图
Schematic diagram of handrail installation

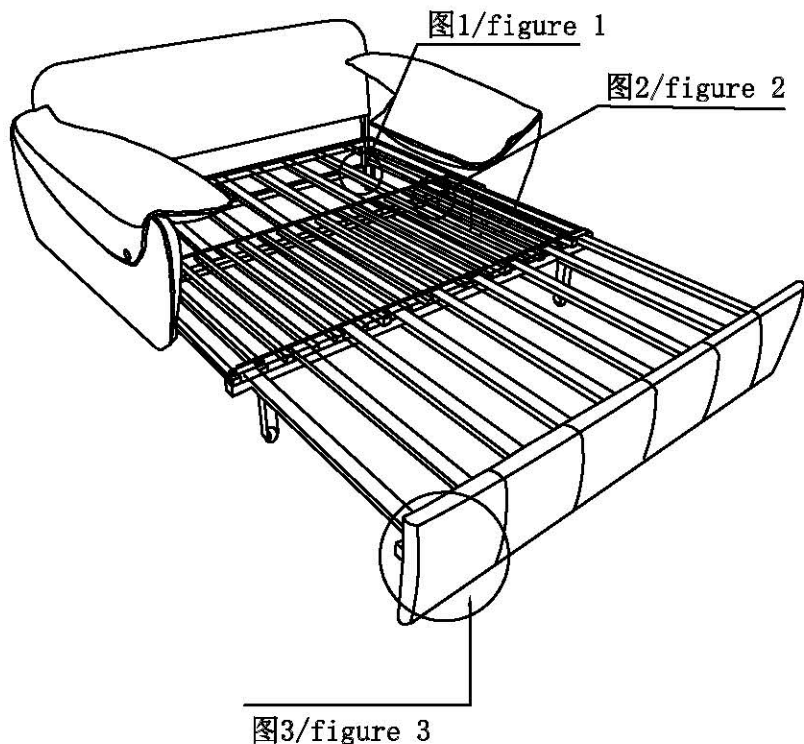

图3: 座前板安装示意图

Installation diagram of the front panel of the seat frame



组合图 Combination

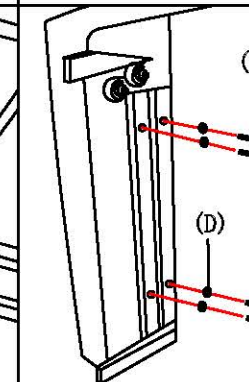
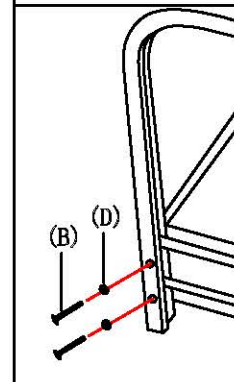
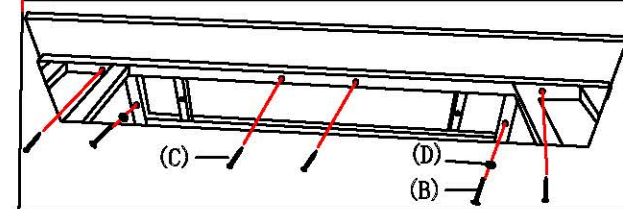
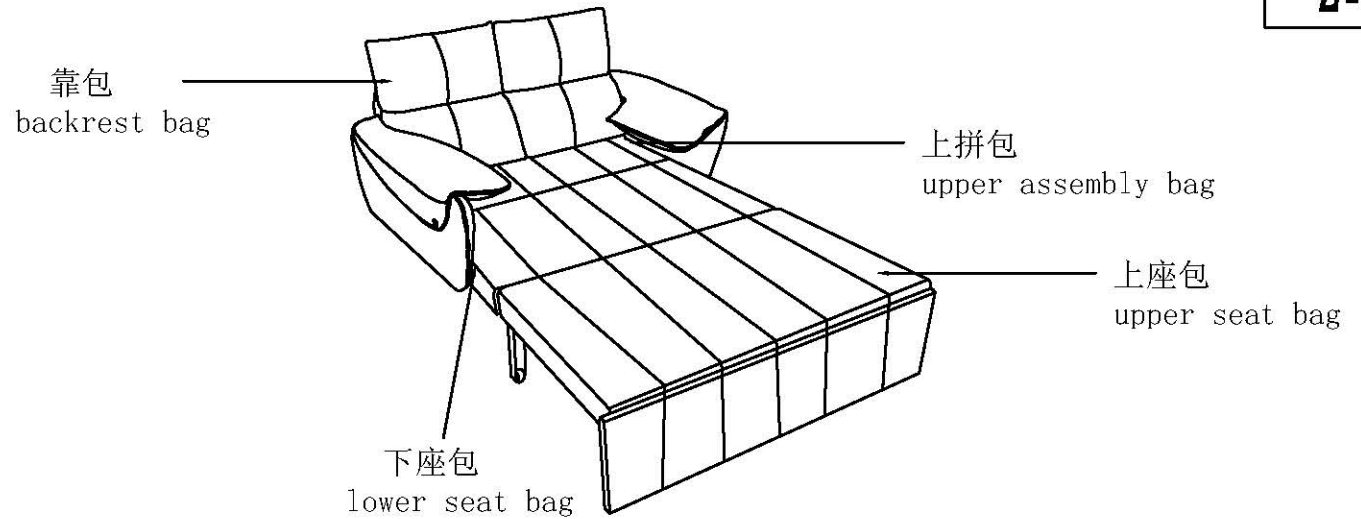

沙发床: 依次放上拼包*1, 下座包*1, 上座包*1, 靠包*2

Sofa bed: Place the upper assembly bag *1, the lower seat bag *1, the upper seat bag *1, and the backrest bag *2 in sequence

组合图 Combination

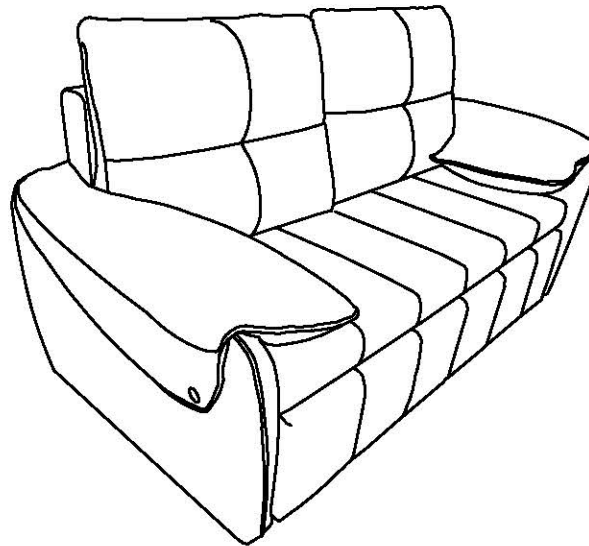

沙发: 依次放上下座包*1, 上座包*1, 上拼包*1, 靠包*2

Sofa: Place the upper and lower seat bags *1, the upper seat bag *1, the upper assembly bag *1, and the back bag *2 in sequence

注:

1) 安装图图示方向为指示方向, 具体左右摆放方式以实物为准。

The direction shown in the installation diagram is the indicated direction, and the specific left and right placement method is subject to the actual object.

2) 产品安装图中产品规格涵盖了该款式的完整组合件, 详细配套组合件请参考实物。

The product specifications in the installation diagram cover the complete assembly of this style. For detailed matching assembly, please refer to the actual product.

LINSY 林氏家居

安装示意图/Assembly Instruction

如何区分沙发的左右方向?
How to zone the left and right direction of the sofa?

(图示仅供分辨方向用/Picture are for orientation only)

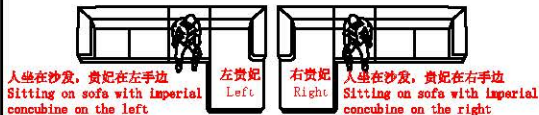

安装人数
Installer



充电式手电钻Cordless hand drill

或者Or



十字螺丝刀Phillips screwdriver

客户安装前须知:

Customers need to know before installation:
此安装图为“双人”的位置关系。
This installation picture is "Loveseat"

2-1

大 四 人 Big Four-seater

产品名称 Model NO.	沙发
产品型号 Product Model	TBS606-BL#
产品组合 Product portfolio	①大四人 Big Four-seater
尺寸规格 Specification	①(2110*870*1030)

成品部件明细 Product Parts Details	编号 NO.	名称 Name	规格 Specification	数量 QTY	材质 Material
1	大四人 Big Four-seater	2110*870*1030	1	胶合板+海绵+人造皮+铁 Plywood + Sponge+Artificial leather+iron	
制图 Draw		C40			

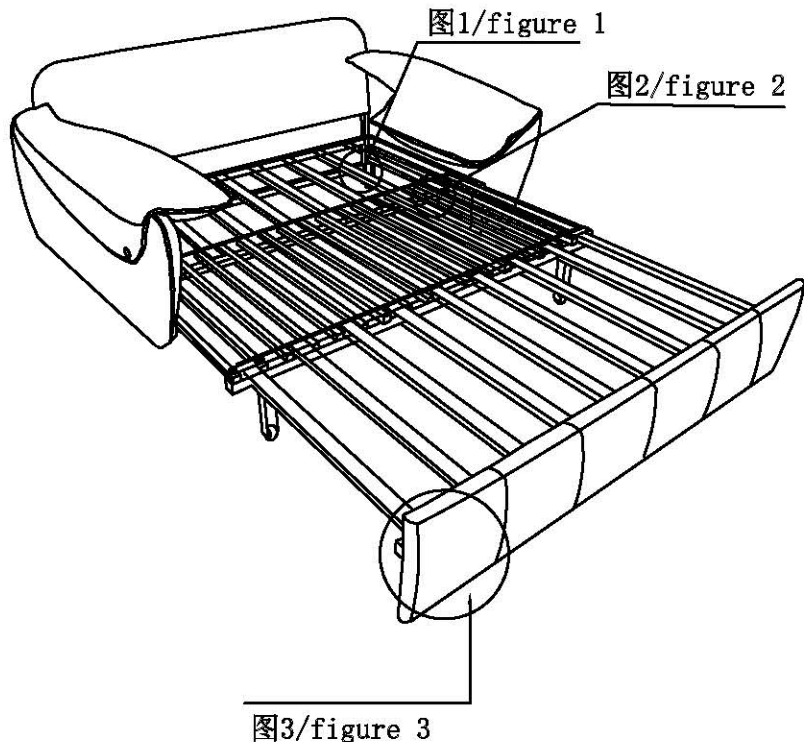

配件表 Accessories list

编号NO.	名称 Name	图示 Icon	数量 QTY	大四人 Big Four-seater
A	说明书(含安装图) Mounting Instruction (with drawing)		1	1
B	M8*50斜边十字螺栓 M8*50 bevel cross bolt		14	14
C	M5*50自攻螺丝 M5*50 self tapping screw		4	4
D	M8垫片 M8 pad		14	14

图1: 靠背铁架安装示意图
Installation diagram of the backrest iron frame

图2: 扶手安装示意图
Schematic diagram of handrail installation



图3: 座前板安装示意图

Installation diagram of the front panel of the seat frame



组合图 Combination

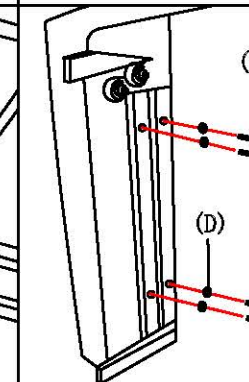
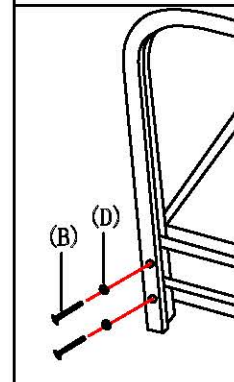
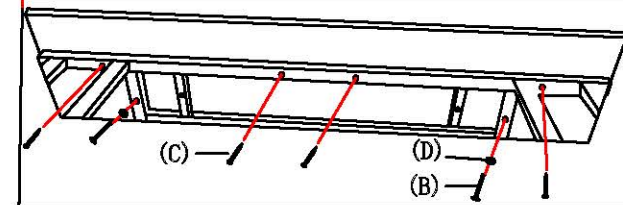
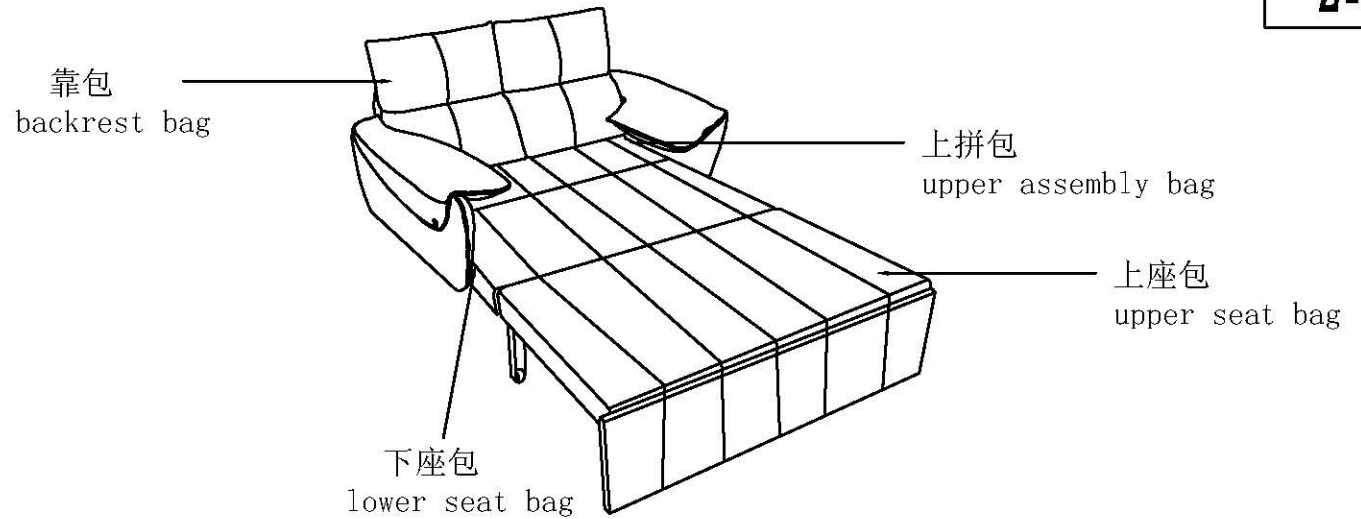

沙发床: 依次放上拼包*1, 下座包*1, 上座包*1, 靠包*2

Sofa bed: Place the upper assembly bag *1, the lower seat bag *1, the upper seat bag *1, and the backrest bag *2 in sequence

组合图 Combination

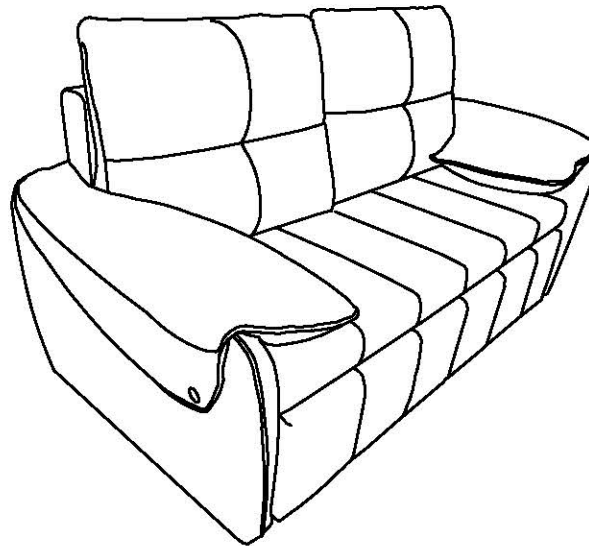

沙发: 依次放上下座包*1, 上座包*1, 上拼包*1, 靠包*2

Sofa: Place the upper and lower seat bags *1, the upper seat bag *1, the upper assembly bag *1, and the backrest bag *2 in sequence

注:

1) 安装图图示方向为指示方向, 具体左右摆放方式以实物为准。

The direction shown in the installation diagram is the indicated direction, and the specific left and right placement method is subject to the actual object.

2) 产品安装图中产品规格涵盖了该款式的完整组合件, 详细配套组合件请参考实物。

The product specifications in the installation diagram cover the complete assembly of this style. For detailed matching assembly, please refer to the actual product.